



INSTALLATION INSTRUCTIONS

Accessory

REAR LOWER TRIM
P/N 08P46-TZ5-200B

Application

2015 MDX

Publications No.

BII 51637

Issue Date

MAY 2014

PARTS LIST

Rear lower trim

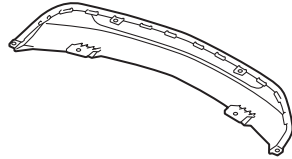

TOOLS AND SUPPLIES REQUIRED

Ratchet

10 mm and 19 mm Socket

The following tool is available through the Honda Tool and Equipment Program. On the iN, click on: Service > Service Bay > Tool and Equipment Program, then enter the number under "Search". Or, call 888-424-6857.

- Trim Tool Set (T/N SOJATP2014)

INSTALLATION

NOTE: Be careful not to damage the rear bumper or other surface of the body.

If the vehicle is equipped with a spare tire, continue with step 1; otherwise go to step 5.

1. Pull each lever, and fold down the left and right third row seats.

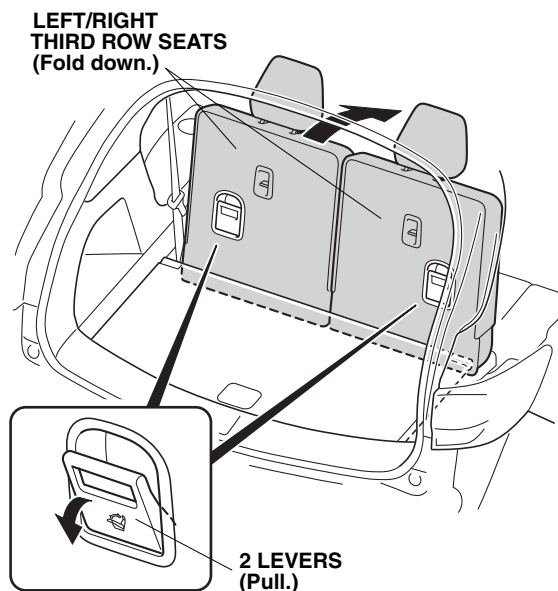

QB01910AH

2. Open the cargo lid.

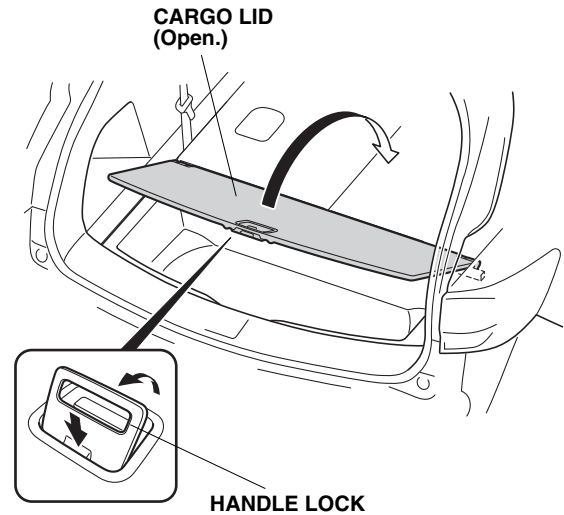

QBN0702AH

3. Remove the cargo lining.

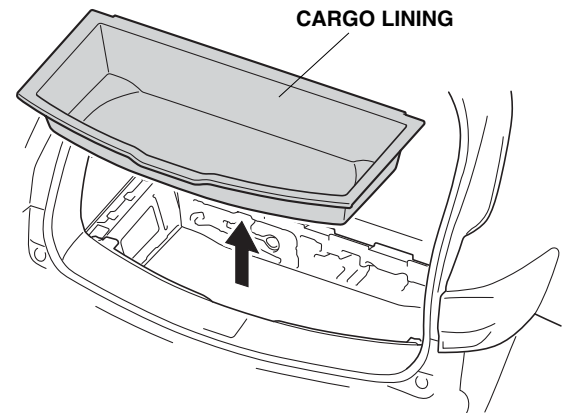

QB01913AH

4. Locate and remove the rubber plug to access the spare tire hoist shaft. Lower the spare tire completely.

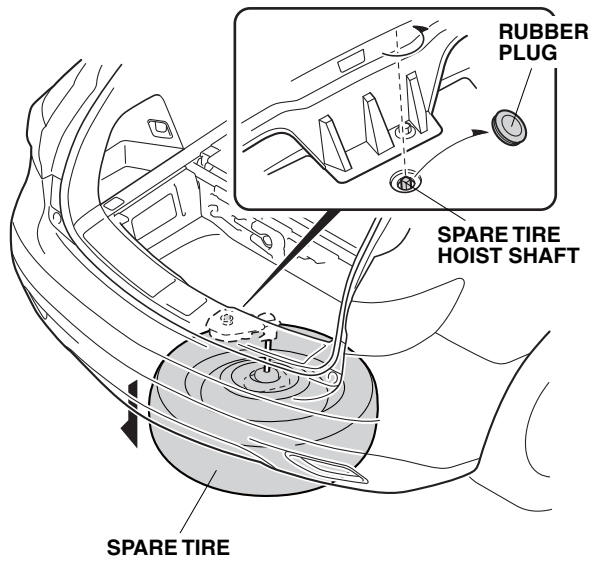

QBN0704AH

5. Under the vehicle locate and remove the rear bumper lower face (4 bolts, 2 clips, and 10 retaining tabs).

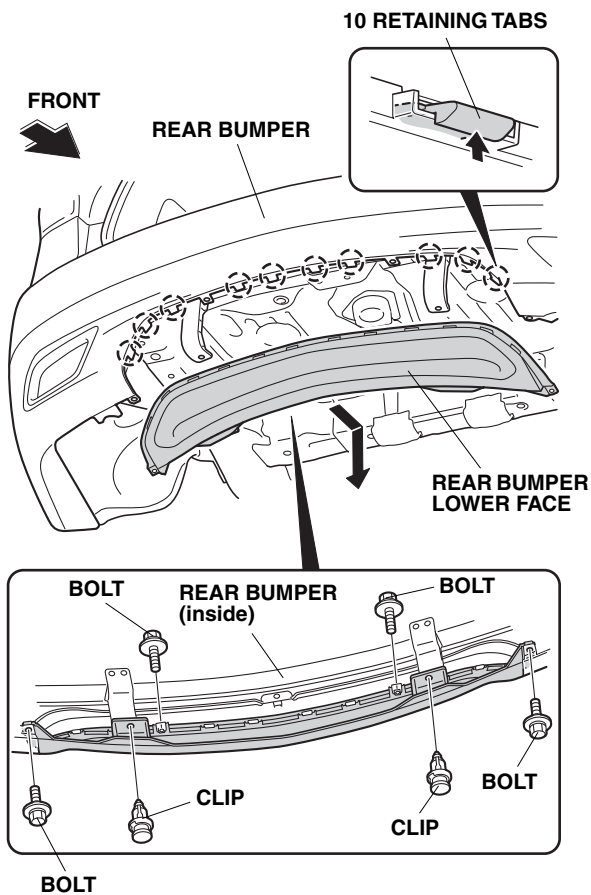

QBN0705AH

Installing the Rear Lower Trim

6. Remove the four clip nuts from the rear bumper lower face, and transfer the four clip nuts to the accessory rear lower trim.

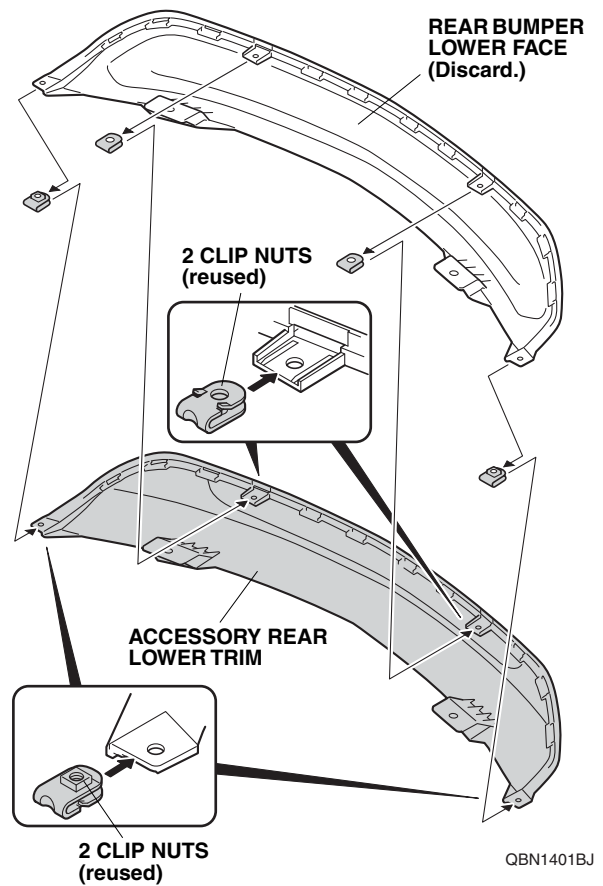

QBN1401BJ

7. Install the rear lower trim to the rear bumper with 4 bolts, 2 clips, and 10 retaining tabs.

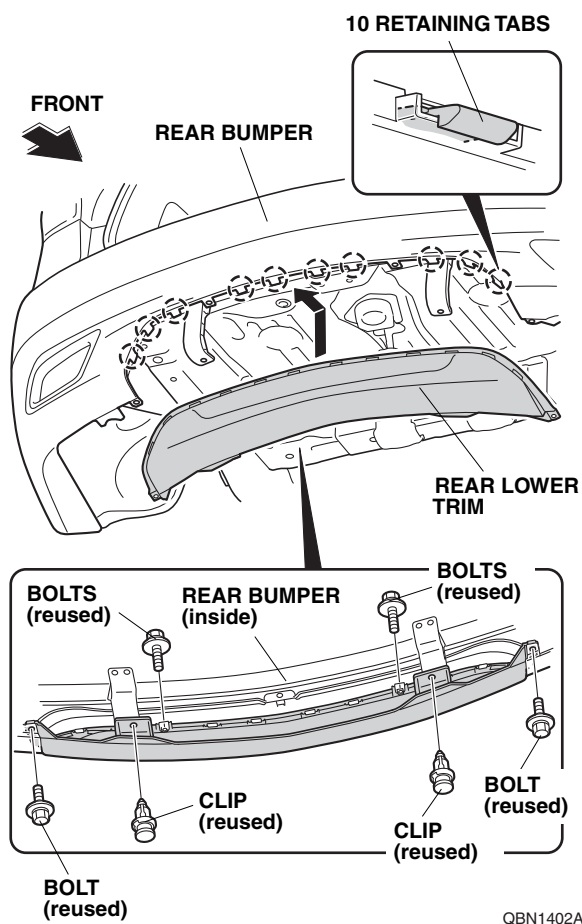

8. Reinstall all removed parts.